

AQUASPIRIT

BOATS CREATE TO INSPIRE

CONTENT

SPIRIT 700	08
SPIRIT 585	14
SPIRIT 530	20
SPIRIT 450C	26
SPIRIT 350S	32
SPIRIT 350C	33
SPIRIT 350	34
SPIRIT 290	36
CONTACTS AND PARTNERS	44

Spend time with your family, go fishing with friends or just enjoy the drive of the waves - all this becomes possible with AQUASPIRIT boats

HONORING THE CRAFT



The Full production circle of high-quality RIB type boats with an aluminum hull for both leisure and professional use.

SPIRIT



SPIRIT models perform a new round in the development of classic RIB boats, representing a combination of our experienced staff, sophisticated technology and high-quality materials. Stylish and ergonomic design, diverse product range, optimal weight and perfect performance features will undoubtedly fulfill all your special requirements. A feeling of drive and euphoric mood while driving SPIRIT boats are difficult to express in words, it is worth going through such a buzz on your own.

EVERYTHING YOU DREAMED OF



Spirit 700 is the flagmanship model of AQUASPIRIT, which combines a modern fast-paced design, incredible interior space with excellent seaworthiness. The concept of creating this RIB boat is the combination of a fully aluminium boat with a D-shaped tube that increases performance and safety. Thanks to the use of a D-shaped tube, a significantly larger internal space has been achieved in comparison with traditional RIB type boats. Not one traditional 7m long RIB offers as much space as the SPIRITS 700 - a new level with an internal width of more than two meters.

SPIRIT
700

S700 - impresses by creating stylish, modern and user-friendly designs using sophisticated and ingenious solutions from marine aluminum.



S700 - with the wide variety of additional options, you can create the boat of your dreams.



SPIRIT 700

Precisely calculated hydrodynamics of the hull and the excellent seaworthiness are the advantages that are characteristic of all SPIRIT models. The deep V-shaped hull of the SPIRITS 700 allows you to enjoy riding both on smooth water and on sea waves. Stop searching, you found it!
SPIRIT 700 - Quality and comfort in a new fresh look, all at once.

MODEL	CAPACITY	LOAD	POWER	BEAM	LENGTH
SPIRIT 700	11 ppl	1340 kg	250 h.p.	2,85 m	6,995 m

ATTENTION TO DETAILS

SPIRIT
700

- Deep V aluminum hull, 210
- Hydraulic steering system
- PVC deck covering
- Storage lockers
- Hull ventilation system
- Self-draining cockpit
- Built in fuel tank (300L)
- Electric pump (12V)
- Automatic bilge pump
- Battery container
- Ladder
- Bow platform
- Set of cushions (as shown on the picture above)
- Navigation lights
- Rails

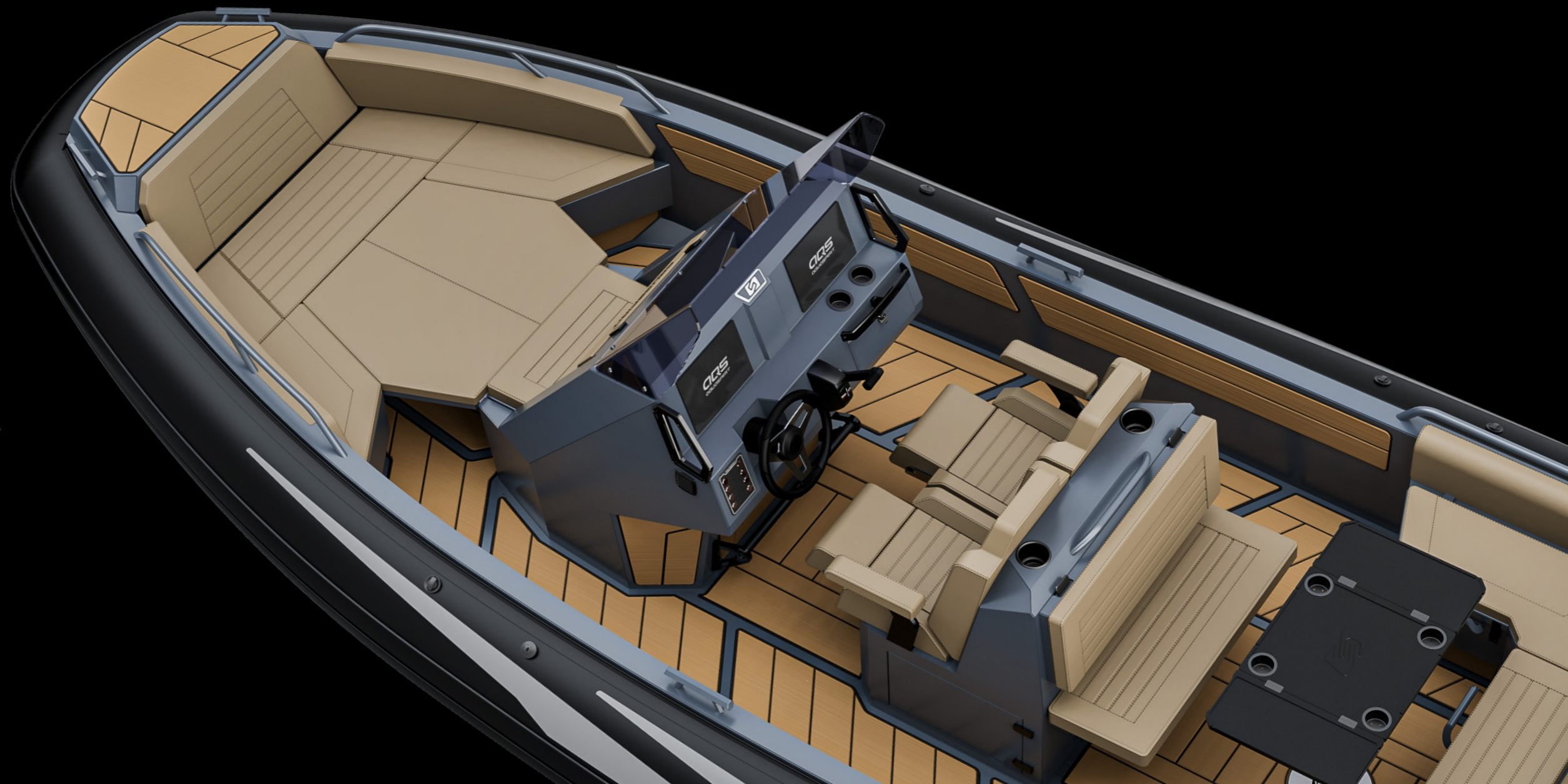

VERSATILITY IS A SUPERPOWER

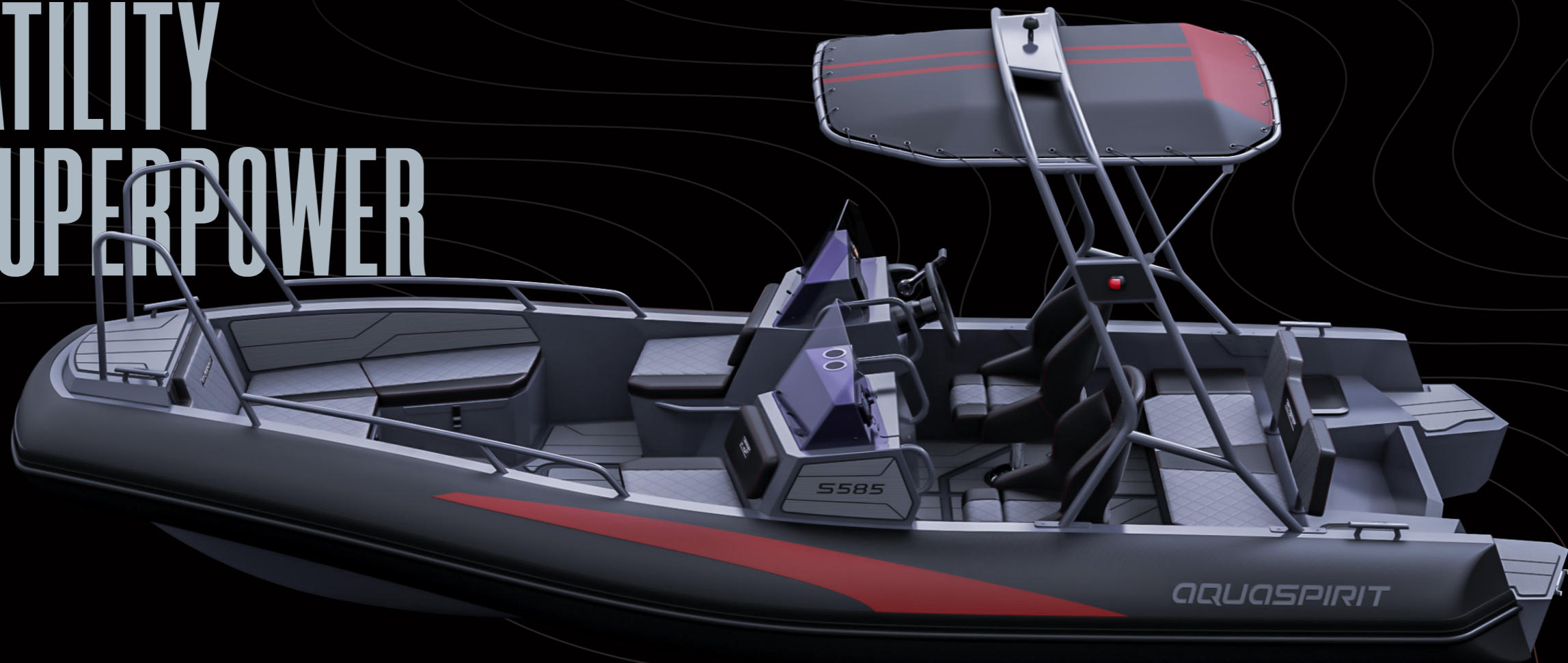

Spirit 585 with D-shape tube, provides what you'd expect from a much larger RIB but with robustness to the extreme. Two console options (dual or conventional center console) and space for up to 9 passengers.

SPIRIT
585

S585 DC - two aluminum consoles located on the sides of the boat distinguish it from the traditional models of competitors.

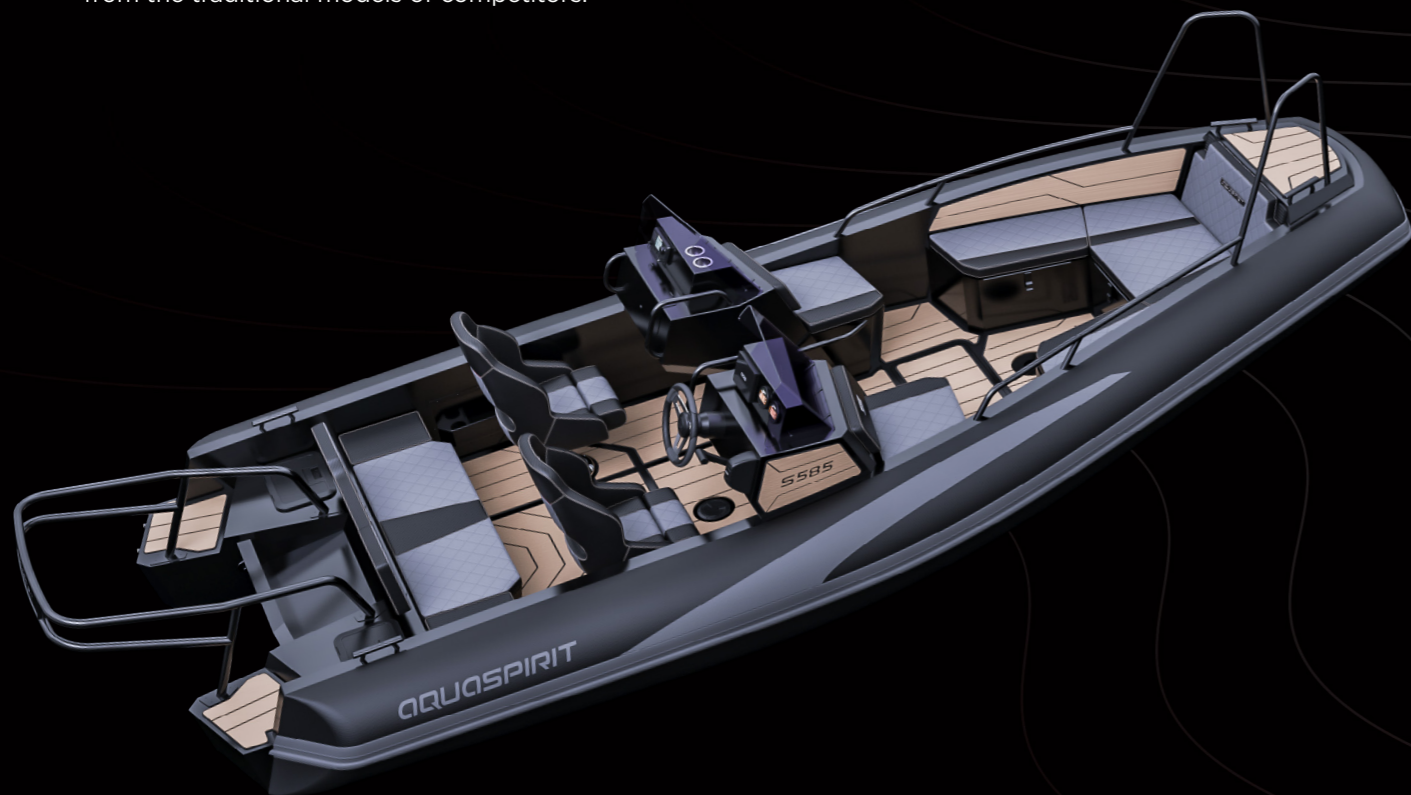

S585 CC with optional arch, bicolor upholstery and gray black seadek

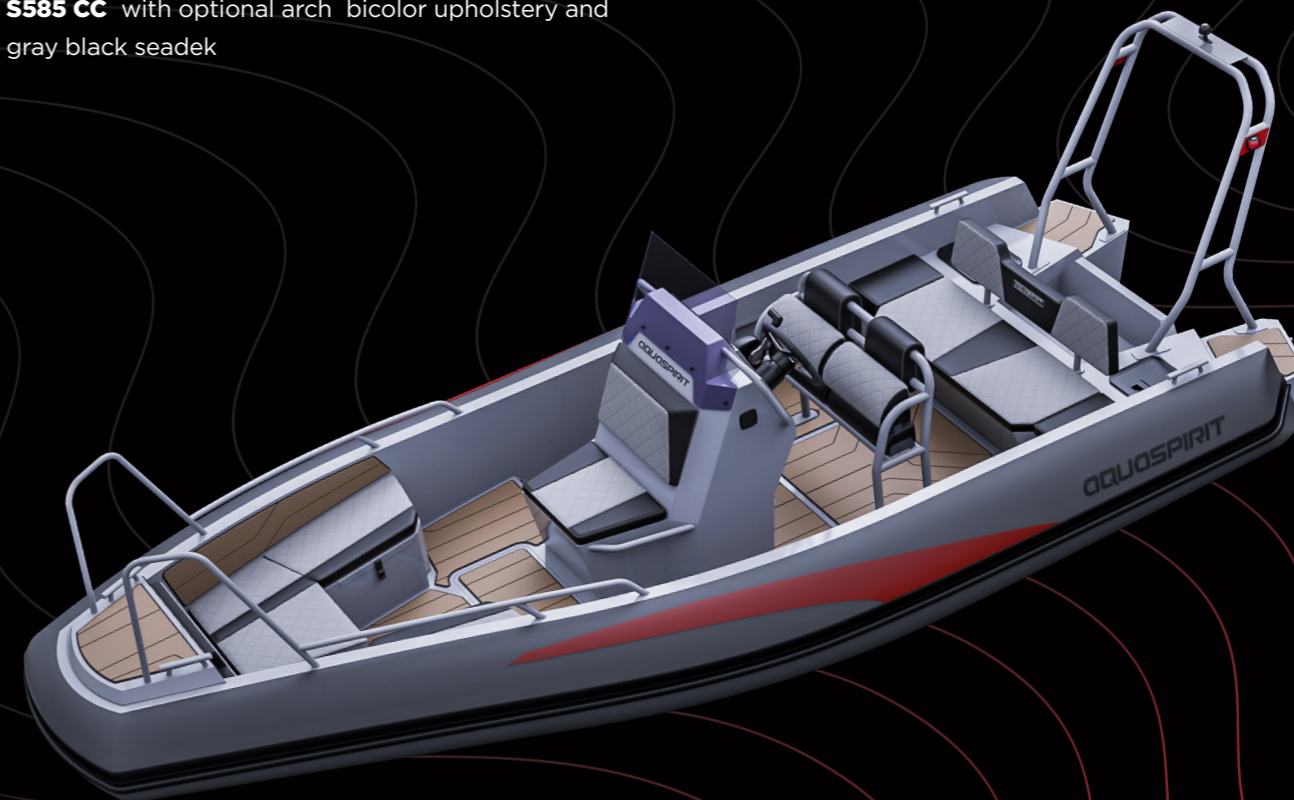

SPIRIT
585

There is hardly a boat of this size that is so grown-up, but also equally agile and sporty as the SPIRIT 585.

MODEL	CAPACITY	LOAD	POWER	BEAM	LENGTH
585 DC/CC	9/8 ppl	1050 kg	150 h.p.	2,46 m	5,85 m

ATTENTION TO DETAILS

- Marine aluminium hull EN AW5083-H111
- Aft platforms
- Central steering console
- Stern seat
- Bow seat
- Anti-slip coating on deck
- Steerin system
- Battery box 100Ah
- Aft handrails for passengers
- Bow railings
- Bowstep platform
- PVC fender profile
- Towing eyelets
- Cleats
- Fuel system (tank 132l)
- Navigation lights
- Main switch
- Switch panel
- Automatic bilge pump
- Forced cockpit pump (since July 2023)
- Front console cushions
- Stern sofa cusions
- Seat cushions behind console

SPIRIT
585



ENGINEERED FOR PERFECTION

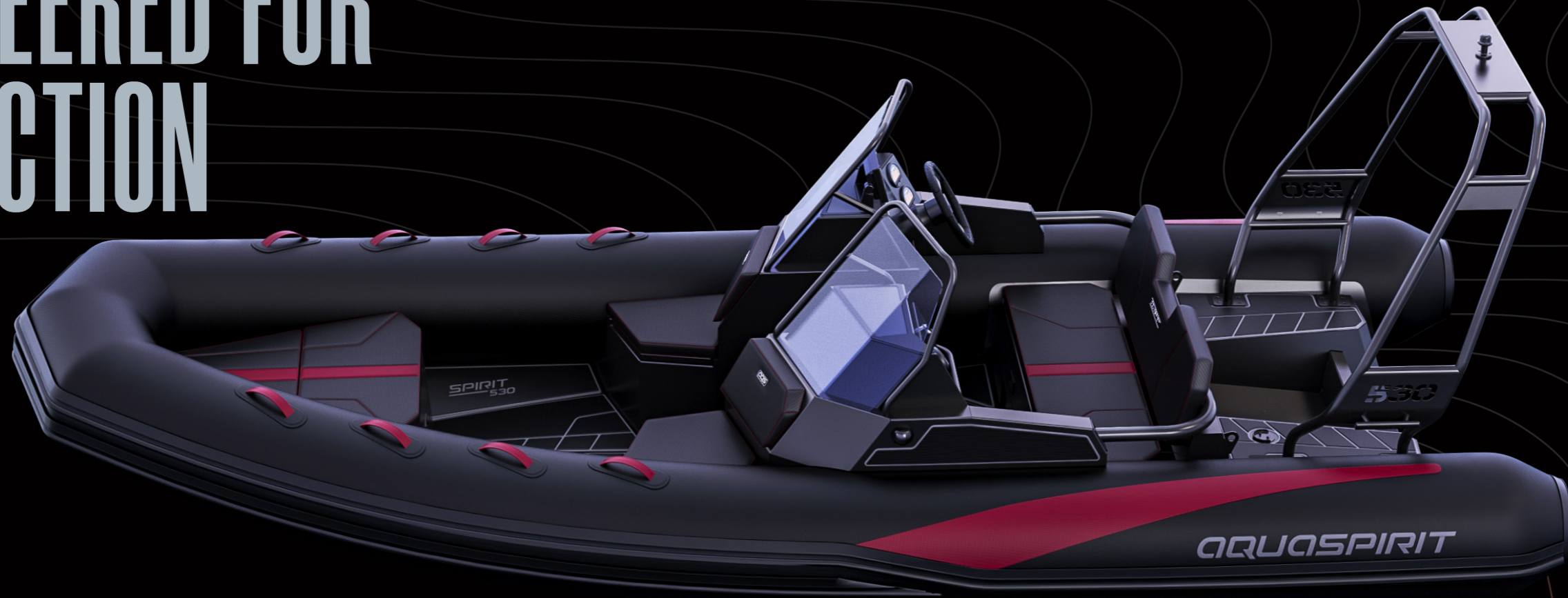

Spirit 530 combining swift forms with a seaworthy hull made of EN AW 5083 aluminum and an innovative interior. The boat demonstrates excellent speed and driving characteristics with engines from 70 up to 100 hp. and is able to satisfy even the most demanding and sophisticated User.

SPIRIT
530

S530 DC - two aluminum consoles located on the sides of the boat distinguish it from the traditional models of competitors.



S530 CC - exceeds all expectations for a RIB of this size. It handles incredibly mature, stable, safe and very seaworthy.

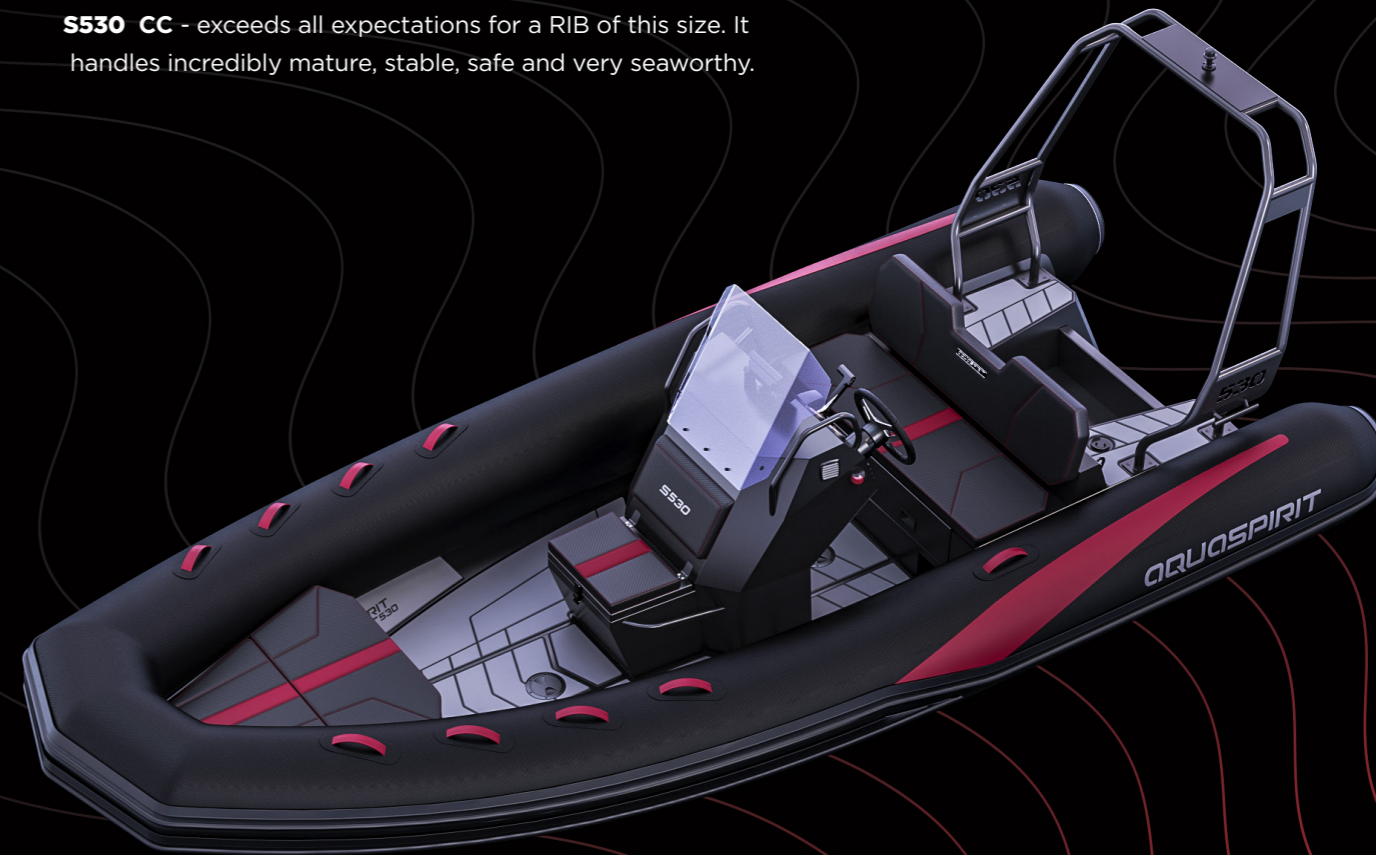

SPIRIT
530

Well-orchestrated body lines allow distinctive ride over the waves in different weather conditions. Perfect stability and a light buoyancy will guarantee a comfortable ride. Inner installation of seats offers comfortable accommodation for a crew of 7 people.

MODEL	CAPACITY	LOAD	POWER	BEAM	LENGTH
530 DC/SC	7 ppl	1000 kg	100 h.p.	2,31 m	5,35 m

ATTENTION TO DETAILS

SPIRIT
530

- Marine aluminium hull EN AW5083-H111
- Aft platforms
- Double or central steering console with windshield and seating/steering and pas. consoles with front seat
- Anti-slip coating on deck
- Steerin system
- Battery box 60Ah
- PVC fender profile
- Towing eyelets
- Fuel system (tank 62l)
- Navigation lights
- Towing eyelets
- Main switch
- Switch panel
- Automatic bilge pump
- Front console cushions
- Stern sofa cusions

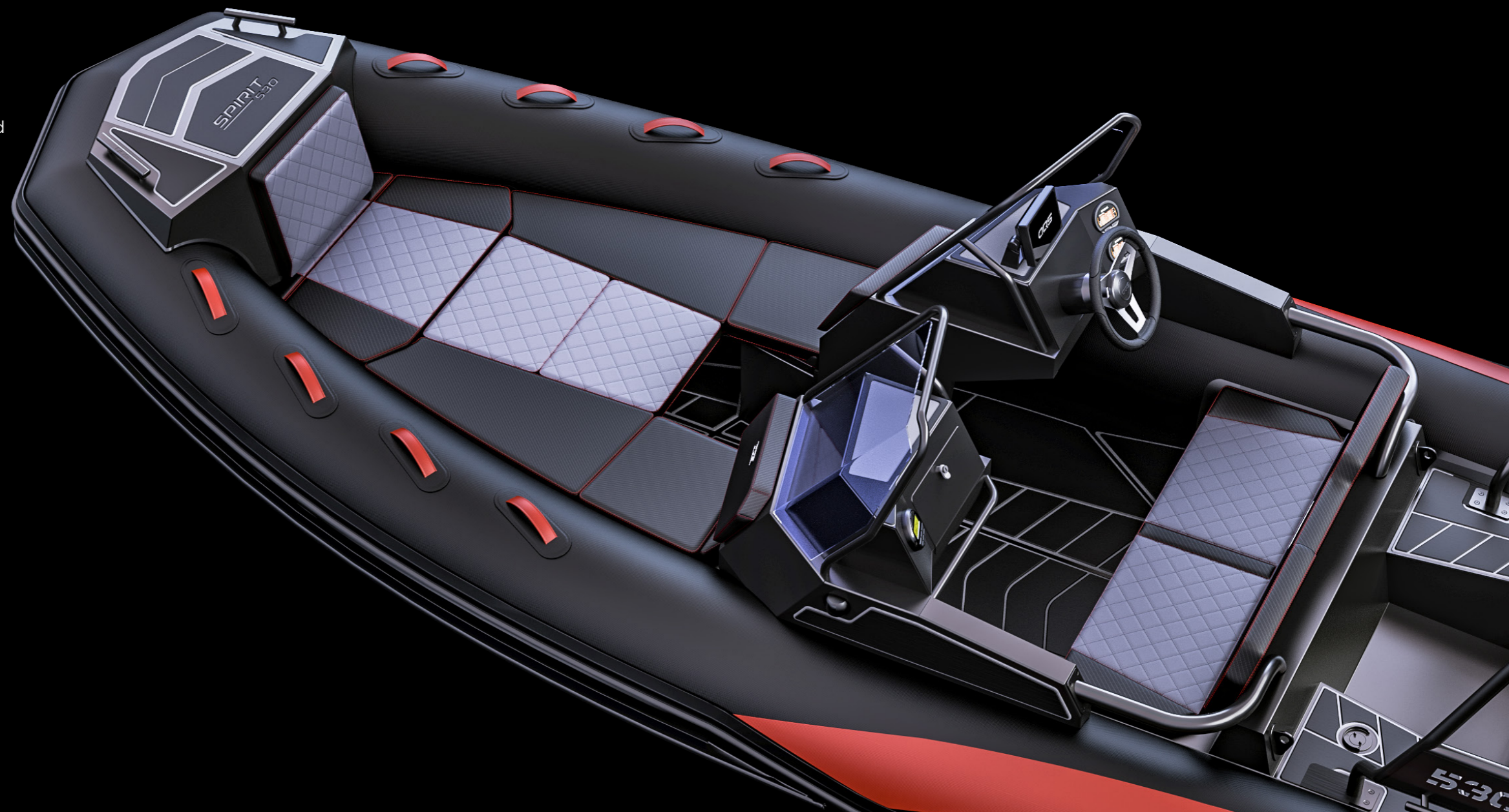

A HIGHER STANDARD

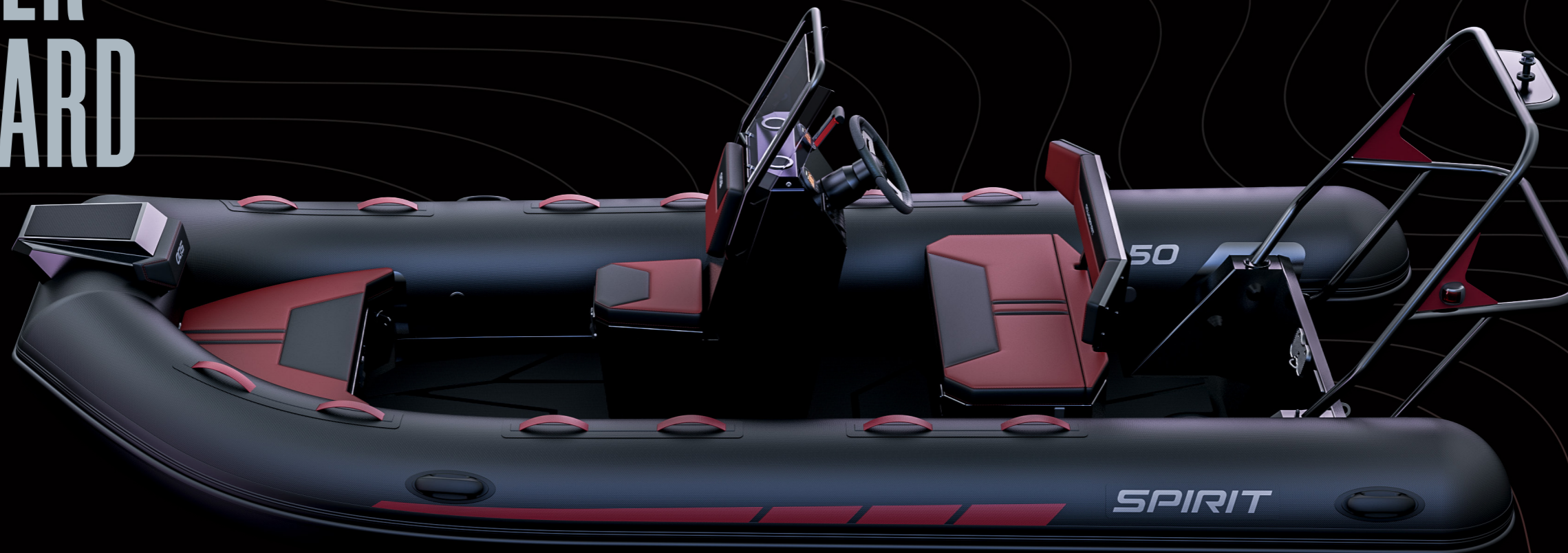

SPIRIT 450 is distinguished by its versatility, which provides possibility to use the boat for both leisure and professional purposes. This boat is the perfect choice for an active family recreation or a vacation with friends, waterskiing, and cruises. Besides that, due to its layout, the boat offers great opportunities for fishing.

SPIRIT
450C

S450 C - one of the most popular models of AQUASPIRIT Company.

The boat has a large cockpit and a sufficient number of baggage lockers, which is especially valuable for boats of this class.

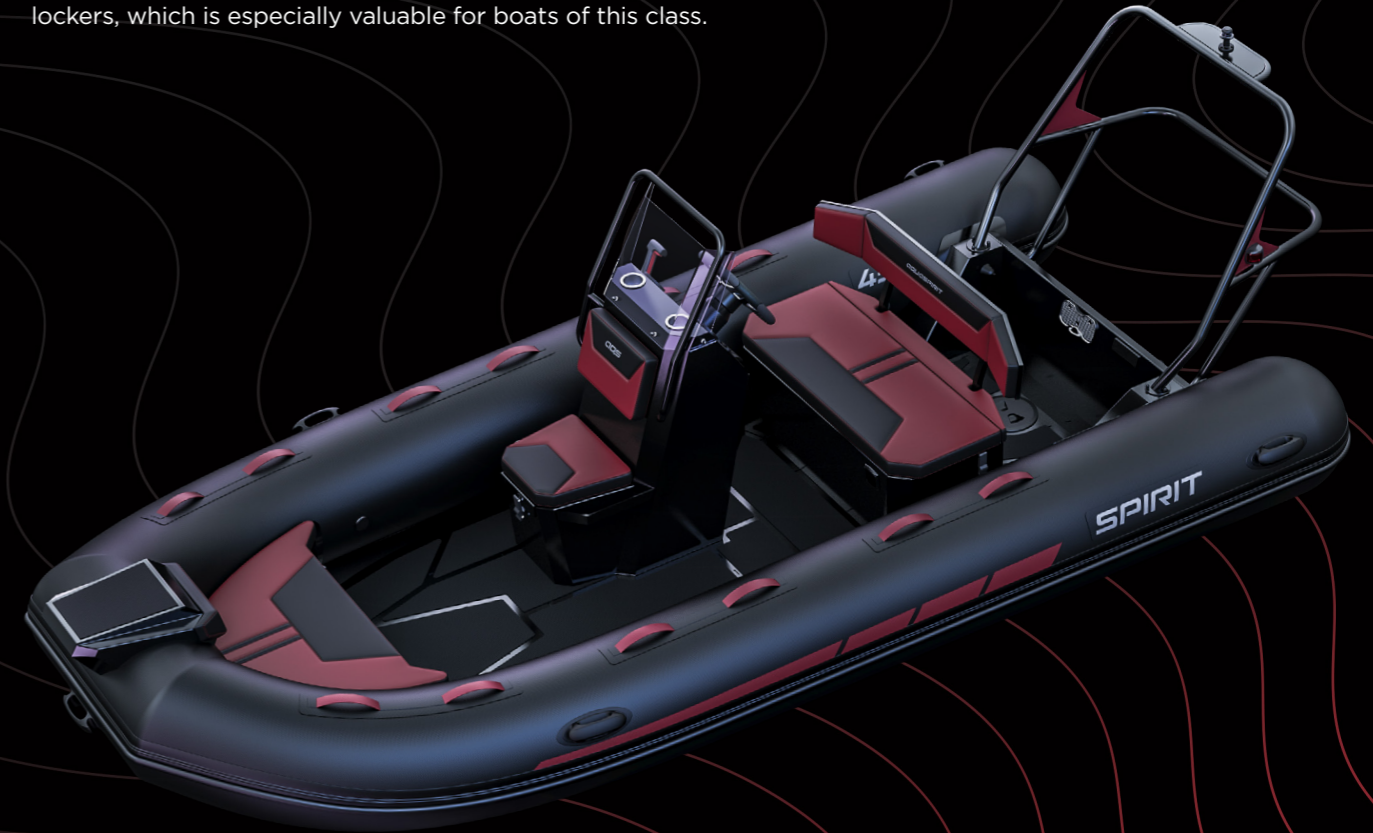

SPIRIT
450C

The company's motto is: Boats created to inspire! The feeling of drive and euphoria that gives the control of the boat SPIRIT 450 is difficult to convey in words, it has to be felt by Yourself!

MODEL	CAPACITY	LOAD	POWER	BEAM	LENGTH
450 C	6 ppl	750 kg	75 h.p.	2,14 m	4,42 m

ATTENTION TO DETAILS

SPIRIT
450C

- Marine aluminium hull EN AW5083-H111
- Anti-slip coating on deck
- Steering console with windshield and seat
- Bench seat at the rear
- Bow seat
- Steering system
- Navigation lights
- Automatic bilge pump
- Battery box
- Battery switch
- Switch panel
- Handles
- PVC fender profile
- Exterior transom pad
- Keel guard
- Tube protection

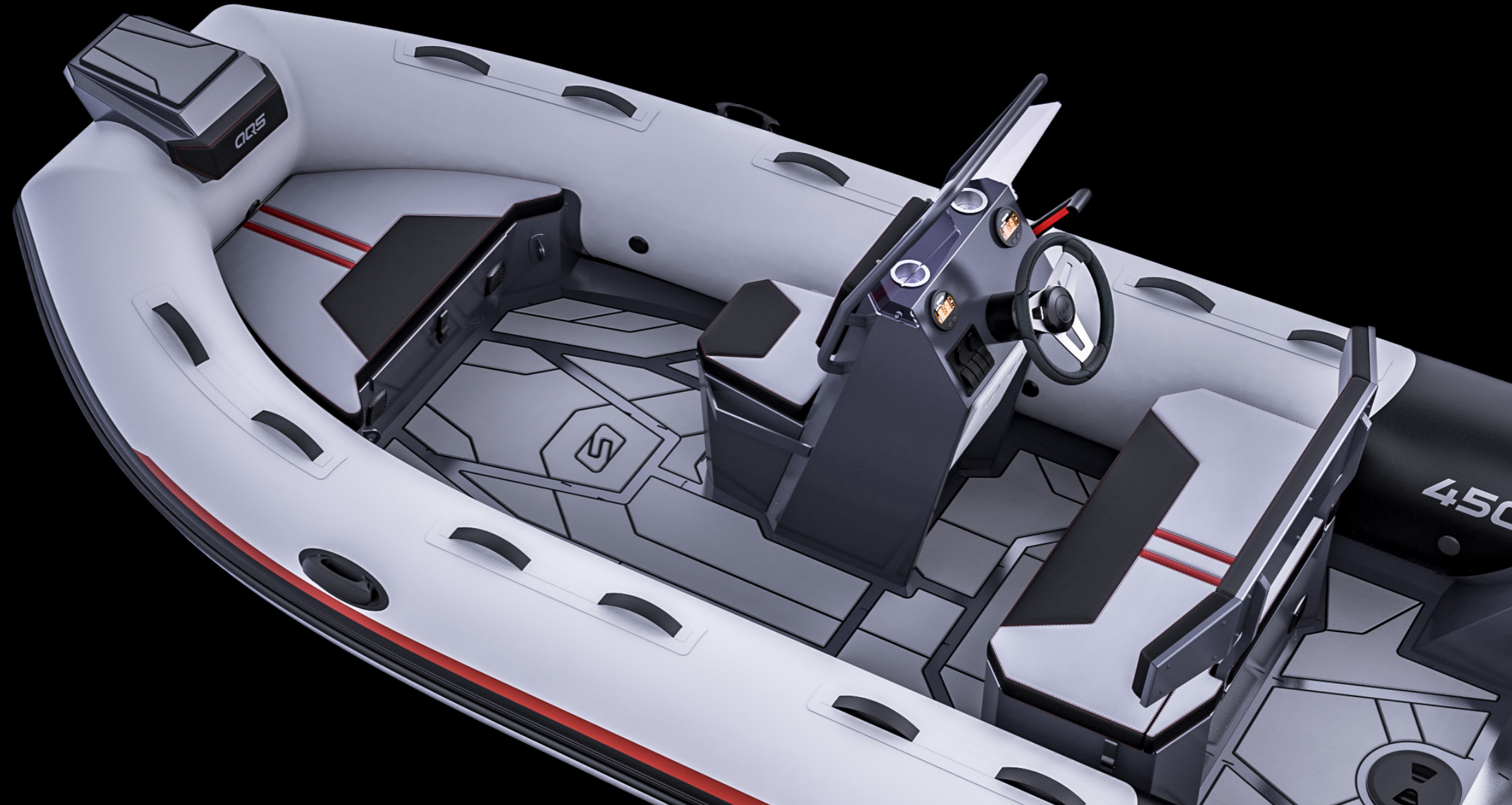

MORE POWER TO YOU



SPIRIT 350C seems to be an eye-opener for leisure sports! An alliance of aluminum hull and a tube will give you an opportunity to benefit from cruising a boat with a rigid body design.
Maximum engine capacity accepted for installation equals 30 hp.

SPIRIT
350S

S350 SC - sport combines the driving experience of a jet ski with the easy handling of an inflatable boat.

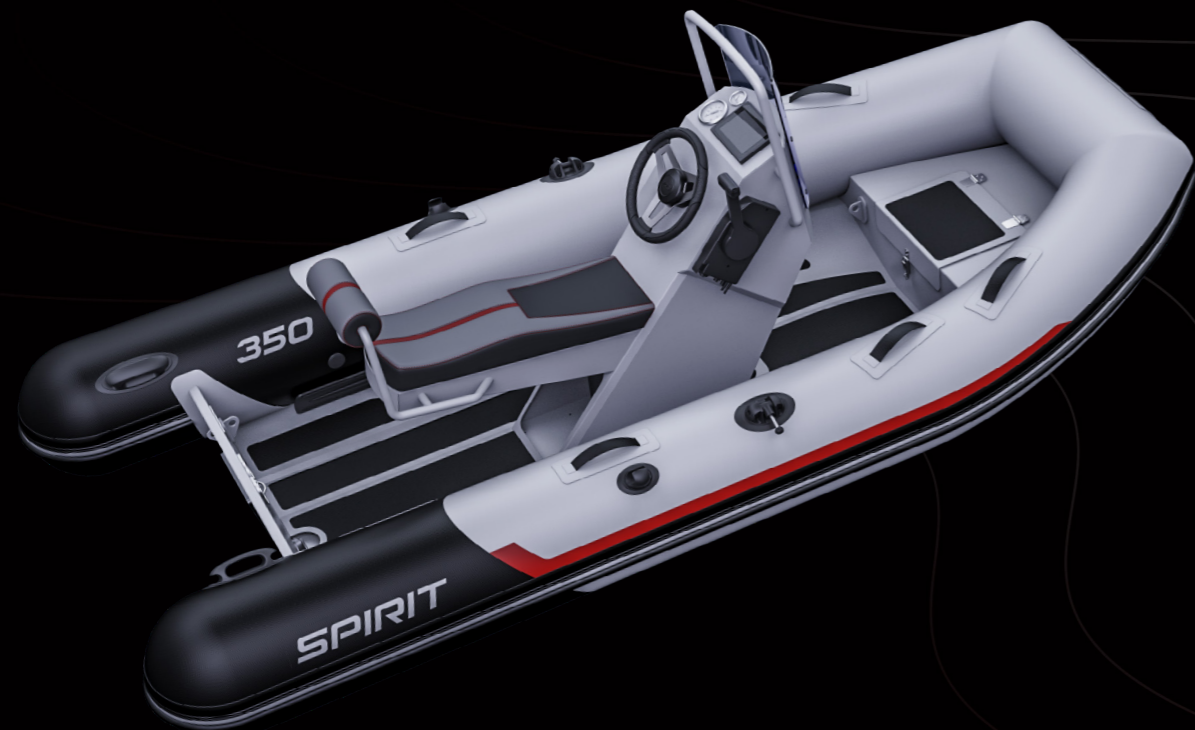

S350 C with a bench seat for two people and a side console with a steering wheel



SPIRIT
350

The 350 models are ideal tenders for superyachts. This line of aluminum boats has compact dimensions and a spacious cockpit. Thanks to their lightweight and attractive design, these boats will perfectly complement the yacht and provide a reliable connection to the mainland.

MODEL	CAPACITY	LOAD	POWER	BEAM	LENGTH
350 SC/C	4 ppl	506 kg	30 h.p.	1,68 m	3,50 m

TRADITION MEETS PROGRESS

SPIRIT 350, 320 and 290 are the perfect companions for your sailing or motor yacht. They combine light weight and great robustness. Attributes highly valued by seasoned seafarers. These models have the same structure and differ only in terms of length and seat thwarts and additionally, can be supplied with a side console, which is designed for being remotely controlled.



350

CAPACITY	LOAD	POWER	BEAM	LENGTH
4 ppl	520 kg	30 h.p.	1,68 m	3,50 m

320

CAPACITY	LOAD	POWER	BEAM	LENGTH
3+1 ppl	420 kg	15 h.p.	1,68 m	3,20 m

290

CAPACITY	LOAD	POWER	BEAM	LENGTH
3 ppl	390 kg	11 h.p.	1,58 m	2,90 m

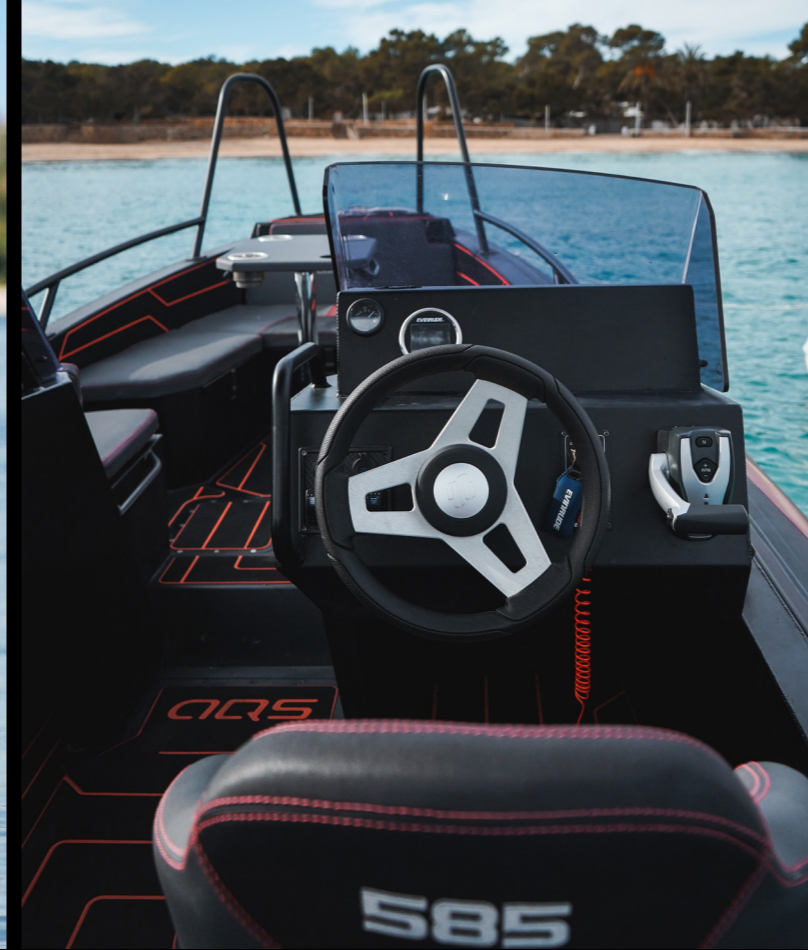



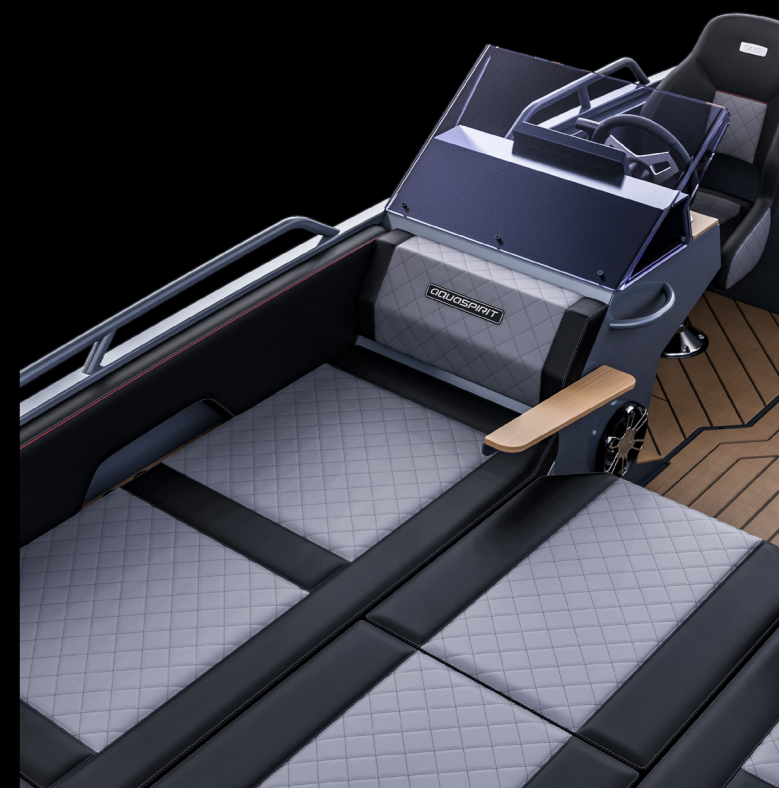
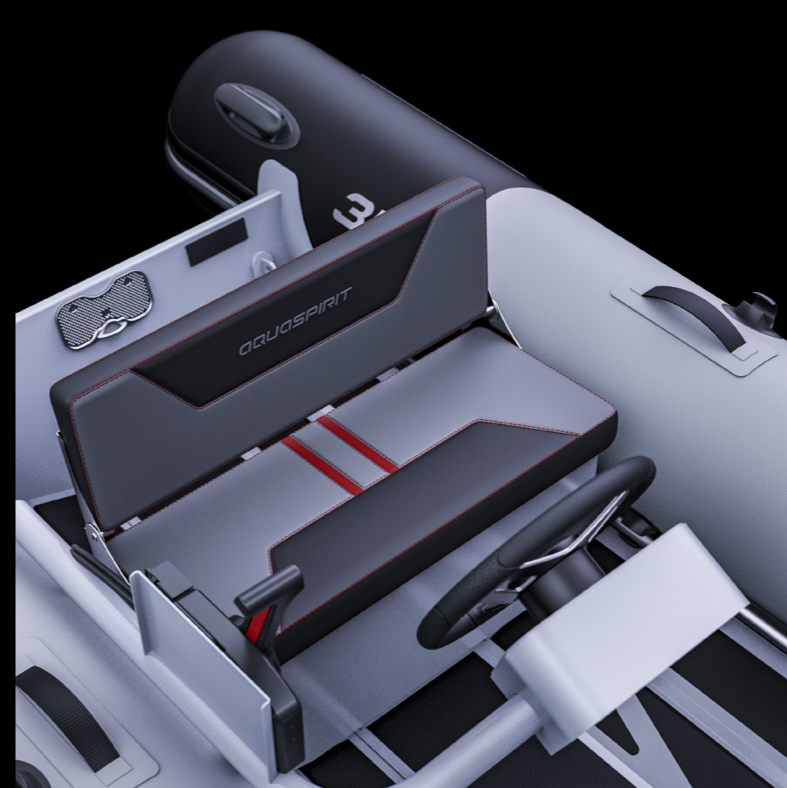

PARTNERS ALL OVER THE WORLD



«AQUASPIRIT»
LLCUkraine, 03083, Kyiv,
Pyrohivskyy shliah, 34

aquaspirit.boats

t./f.: +38 044 351 75 89

t.: +38 050 387 20 67

info@aquaspirit.com.ua

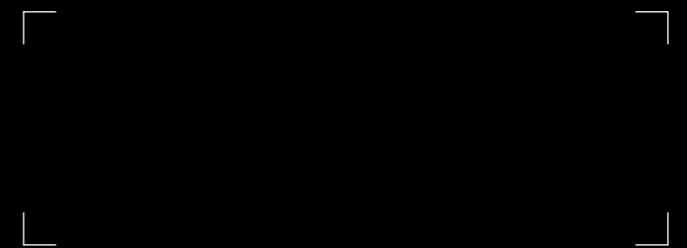

WELCOME TO AQUASPIRIT TEAM



AQUASPIRIT.BOATS